

Indoor Panelboard Installation Instructions
 CAT. NO. 00-10020-000, -200, -300, -400 PANELBOARD & SUB PANEL
 CAT. NO. 00-10020-100 PANELBOARD

Remove Branch KO's

Remove Branch Knock-Out's; place screwdriver as shown and tap end to remove KO. If KO is not completely removed, twist out with pliers.

Main wires

Mains must be installed through this opening using a 1" connector. If a 1-1/4" connector is required, remove Knock-Out ring; place screwdriver as shown and tap end to remove KO ring. If KO is not completely removed, twist out with pliers.

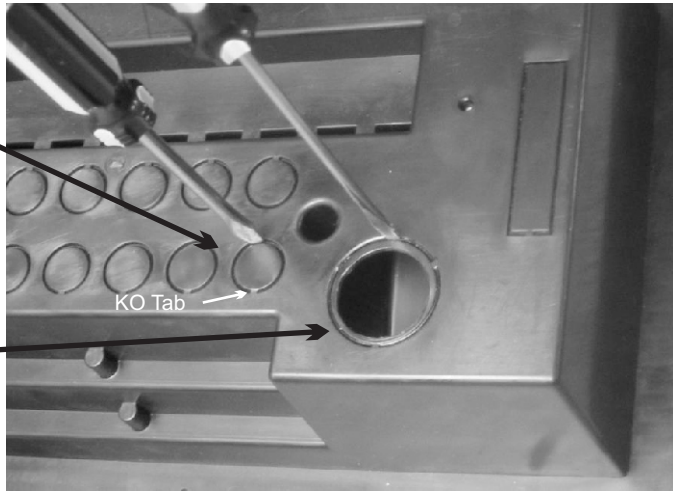

Mount Box

Flush mount box into a 15-5/8" X 8-5/8" opening. Remember to leave 17-1/2" X 10-1/2" minimum clearance for the cover. Using six (6) #8 screws (not provided) attach box to wall using the mounting holes shown. Note: Box may be mounted as shown or rotated 90° clockwise.

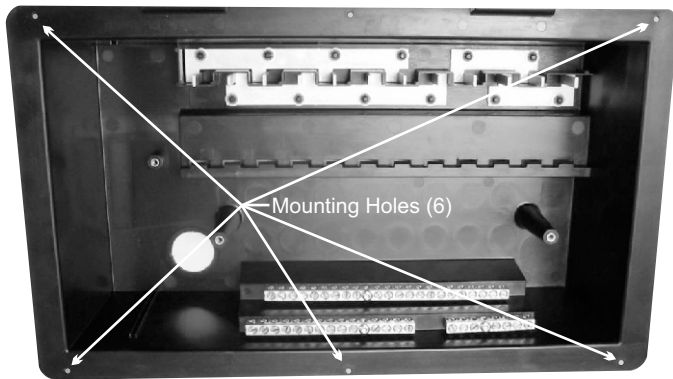

Wire Main, Branch & optional Sub-Panel Circuits

The following breakers are suitable for MAIN and Branch breakers:

- Cutler-Hammer: BR, BD, GFCB, Filler Plate BRFP
- Siemens: QP, QT, Filler Plate QF3
- GE: THQL
- SquareD: HOM, HOMT

Make Certain circuit breakers are in the OFF position prior to installation.

Torque Specifications:

Ground/ Neutral Bar	
Wire AWG	Inch-lbs
14-10	25-35
8	30-40
6-4	35-45

Breaker Hold Down Clamp 3-5 inch-lbs

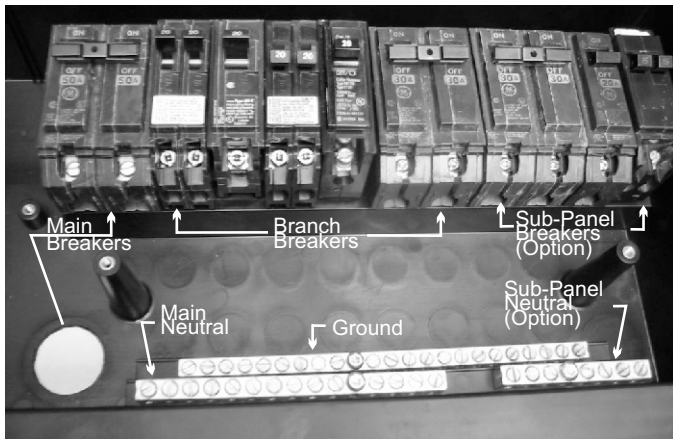

IMPORTANT:

Tighten all electrical connections before energizing. Follow Torque Specifications on the Inside Cover Label.

DANGER:
HAZARD OF ELECTRICAL SHOCK OR BURN. TURN OFF POWER SUPPLY BEFORE WORKING INSIDE.

120/240VAC present inside Panelboard posing potential lethal electrical shock. This equipment should only be serviced by a qualified Service Technician.



Remove Cover Twist-Outs

Twist and remove to create openings for positions where breaker has been installed.

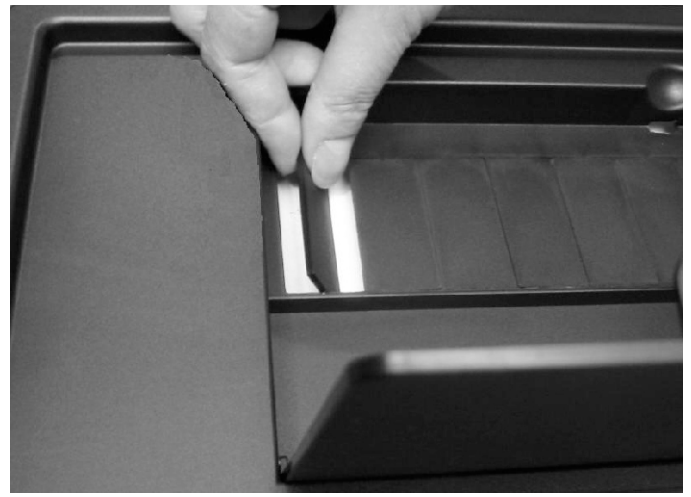

Install Cover

- 1) Slide Cover slots over Box tabs.
- 2) Rotate Cover down to Box
- 3) Screw Cover to Box using two (2) 8-32 X7/16" screws provided.



These instructions do not purport to cover all details or variations in equipment nor to provide for every possible contingency to be met in connection with installation operation or maintenance. Should further information be desired or should particular problems arise which are not covered sufficiently for the purchaser's purposes, the matter should be referred to Precision Circuits Inc.

Route Communication Cables

- 1) If only installing the Power Control System, use above wiring diagram.
- 2) If utilizing the optional Inverter Assist feature, use the below wiring diagram.

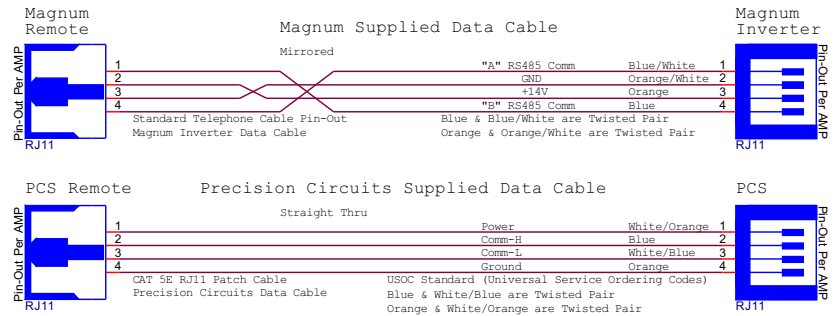

WIRING IF INSTALLING EITHER UNIT ALONE

WIRING IF INSTALLING BOTH UNITS

Connector wiring and pinout does not change only cables lengths and plug-in locations

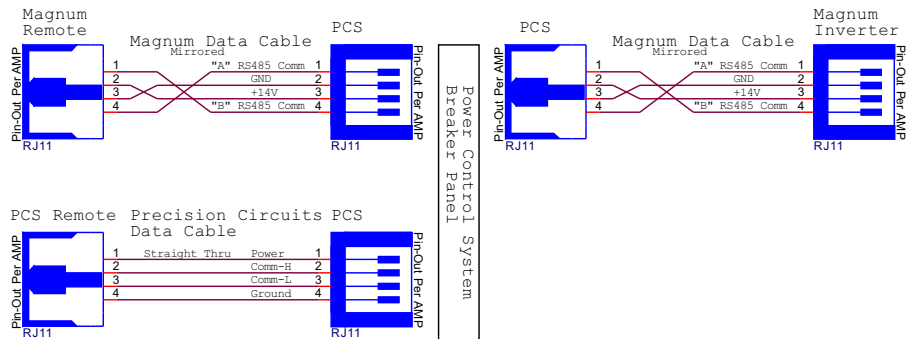

PCS Control Installation Instructions

CAT. NO. 00-10020-500 50AMP PCS CONTROLLER

Install only in Power Control System Panelboards CAT. NO's. 00-10020-000, 00-10020-100

Read & follow Panelboard Instructions for complete Installation

- 1) Prepare Main Supply Cable by removing outer Jacket and cutting and stripping wires to lengths shown.

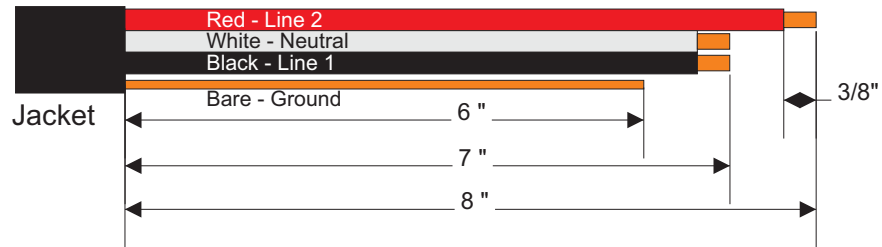

- 2) In the same manner used for the Branch Circuit Knock-outs, remove the rectangular KO to provide access to the 12VDC, and communication connections.
- 3) Install Circuit Breakers into Panel Board.
- 4) Using 1" Connector, (1-1/4" if KO ring is removed) install Main Supply Cable into AC Panel Board knock-out shown, and secure main cable to housing.

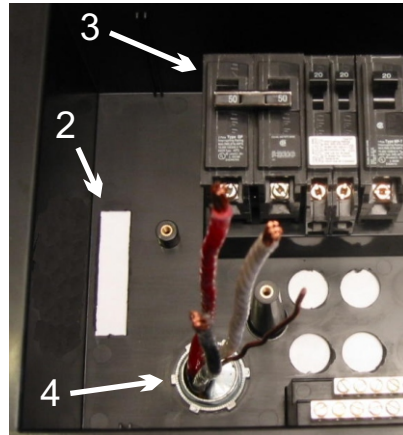

- 5) Bend Ground Wire towards back of box, run along the back, and connect to Ground Block.
- 6) Bend White Neutral Wire towards back of box, run along the back and connect to Neutral Block.

Note: Bend Ground and Neutral wires to clear the Current Sensor Cup for the next step.

Note: it is critical to maintain L1 & L2 relationship throughout the entire installation. For example, the Black wire must go through the L1 Current Sensor hole, connect to the L1 Main circuit breaker, and the PCS Control L1 screw terminals must be connected to the L1 Branch breakers.

- 7) Slide the Black-Line1 and Red-Line2 wires through Current Sensor Cup holes.
- 8) Continue to slide the Sensor Cup/Barrier Wall assembly into the housing guides, until the Wall touches the back of the box.

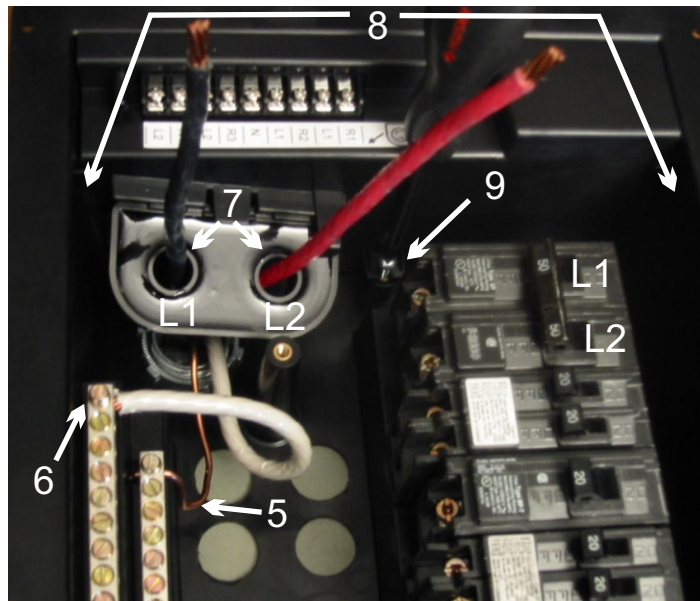

- 9) Secure Current Sensor/Barrier Wall Assembly to Housing using 8-32 X 7/16" screw provided.

- 10) Connect Black-Line-1 and Red-Line-2 supply mains to the corresponding circuit breaker.
- 11) Both Black and Red wires should be below the level of plastic post for easier cover attachment.

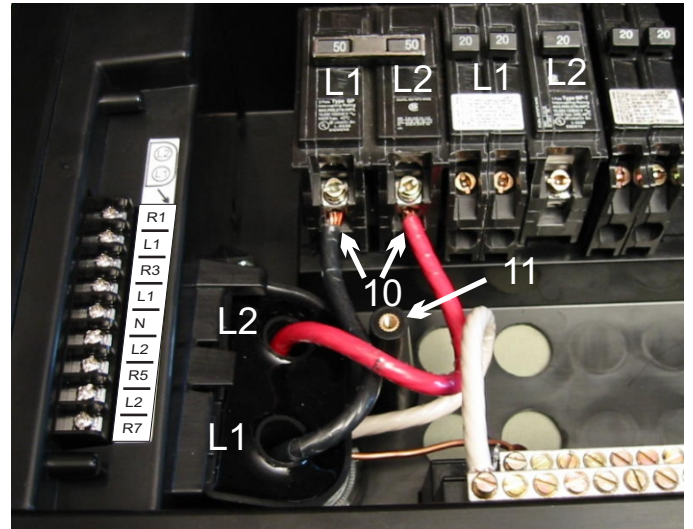

- 12) Wire PCS Control Screw Terminal Block per the diagram.
Screw Terminal Block Torque: 9-in-lbs
 Note: The three Voltage Sense terminals must always be wired for proper voltage sensing and operation, even if corresponding relays are not used.
 Tip: Things like Water Heater, whose circuit breaker is occasionally turned off, should not be wired to Relay 3 or Relay 5.

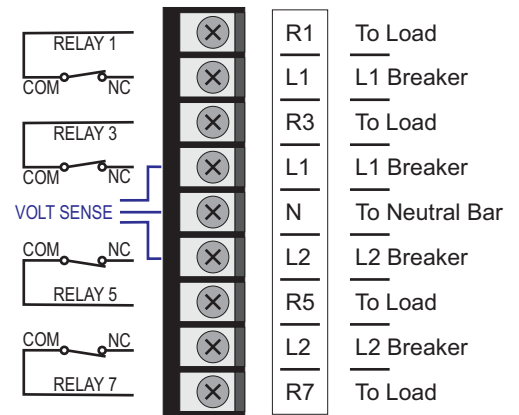

- 13) Make 12VDC connections through the rectangular knock-out located in the back of the box per the diagram on the right and pin-out below.
- 01 GROUND
 - 02 COACH BAT
 - 03 AIR COND 1 NO
 - 04 AIR COND 1 COM
 - 05 AIR COND 1 NC
 - 06 AIR COND 3 NO
 - 07 GEN SET RUN
 - 08 AIR COND 2 NC
 - 09 AIR COND 2 COM
 - 10 AIR COND 2 NO
 - 11 AIR COND 3 NC
 - 12 AIR COND 3 COM

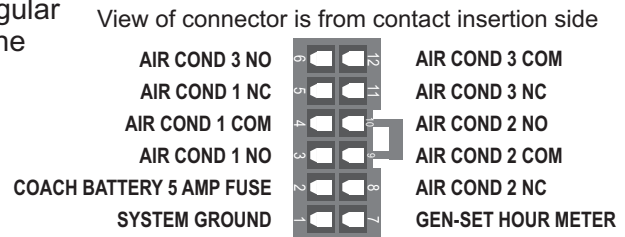

Mating Connector: MOLEX MINI-FIT JR 12-PIN, #39-01-2120
 Contact: MOLEX MINI-FIT JR 5556 18-24 AWG, 39-00-0039

Four different Air Condition Compressor wiring options are shown on the right. Relay Contacts are drawn in Non-Shed or Operation Mode.

Option 1, A/C sheds with Ground Signal

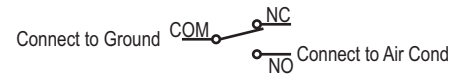

Option 2, A/C sheds with +12V Signal

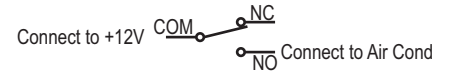

Option 3, A/C operates with Ground Signal

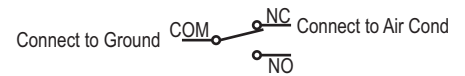

Option 4, A/C operates with +12V Signal

